

Government

Supplemental Activities Common Core Aligned

Mini Student book on Checks and balances, Three branches of Government Fold-ables, Flip-ables and Slide-ables for projects and interactive notebooks.

Government Activities Common Core Aligned

The following activities can be used with 4th – 8th grades to accompany your lessons about the US Government. There are a multitude of YouTube videos, PowerPoints, and internet sites that do a fabulous job of teaching and reviewing the foundation, checks and balances, and responsibilities of our Government. The following activities are meant to supplement and enhance your social studies curriculum with vocabulary cards, flip charts, research forms, note pages for teachers, interactive slide-ables, Executive, Judicial, and Legislative foldables with keys and a mini-book for checks and balances.



Oceans of Teaching Ideas

In this Government Unit

1. Foldable for Government terms
2. Four Term Cards with notes on the back
3. Vocabulary flip-able for Interactive notes or foldable.
4. Blank research tabs on congress that cut and staple into a flip chart for the congress page or interactive notebook.
5. Notes on Congress you can use as an answer key or simply for a student foldable or interactive notebook.
6. How a bill become a law interactive slide-able chart.
7. Executive Branch Foldable
8. Executive Branch Notes Foldable
9. Judicial Branch Foldable
10. Judicial Branch Notes Foldable
11. Understanding our government's Checks and balances mini book. Review of content vocabulary and skill. Cloze style.

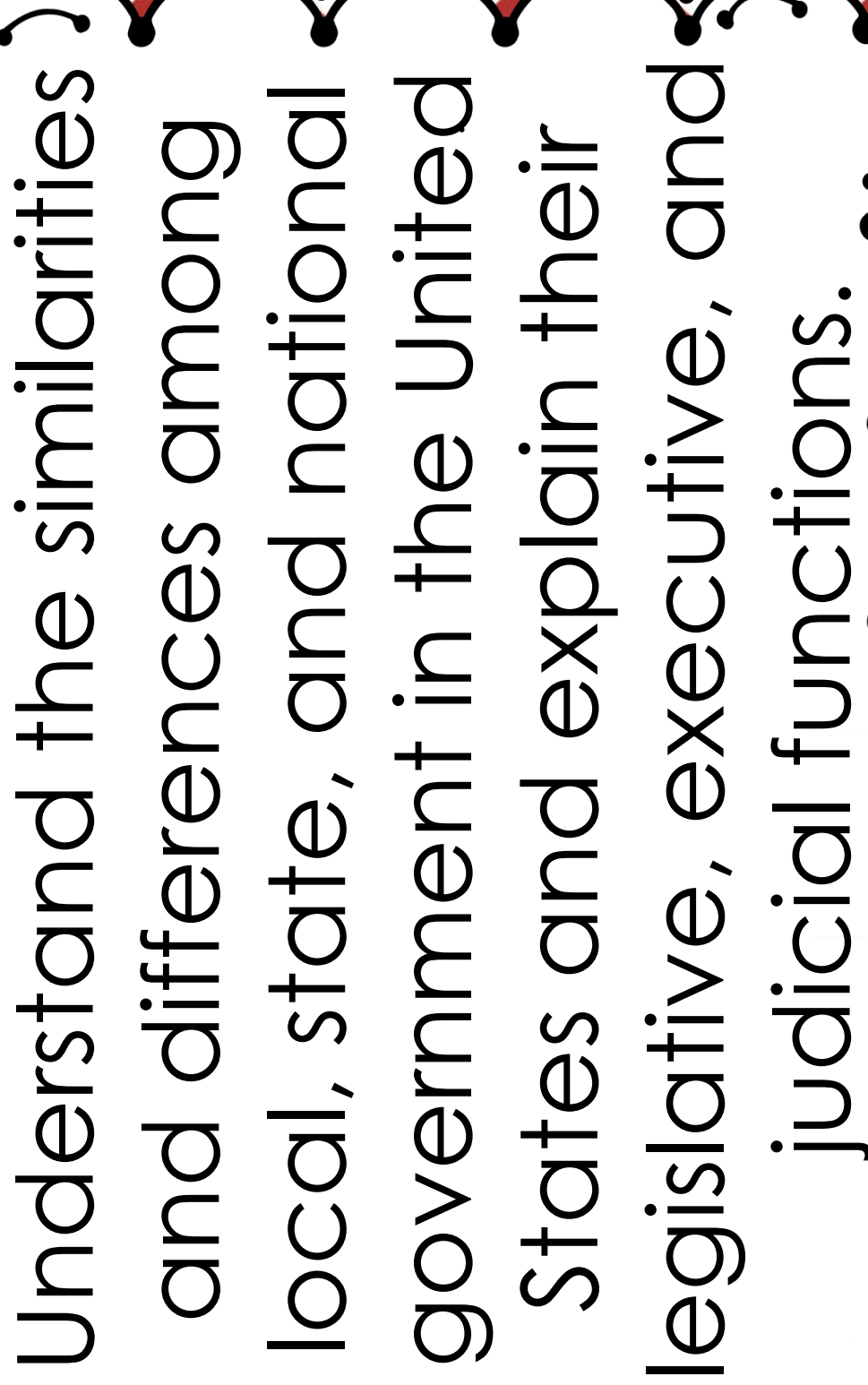

Understand the similarities and differences among local, state, and national government in the United States and explain their legislative, executive, and judicial functions.

government
terms

vocabulary cards

Judicial
Branch

Legislative
Branch

Executive
Branch

Checks &
Balances

democracy

rights

bill

citizen

liberty

*important vocabulary about
our government*

justice

amendment

constitution

Declaration
of
Independence

Bill of Rights

Congress

Glue down
flip chart
here!

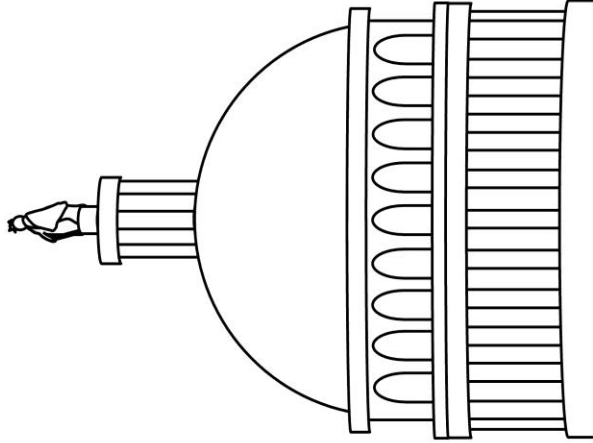

Glue down
flip chart
here!

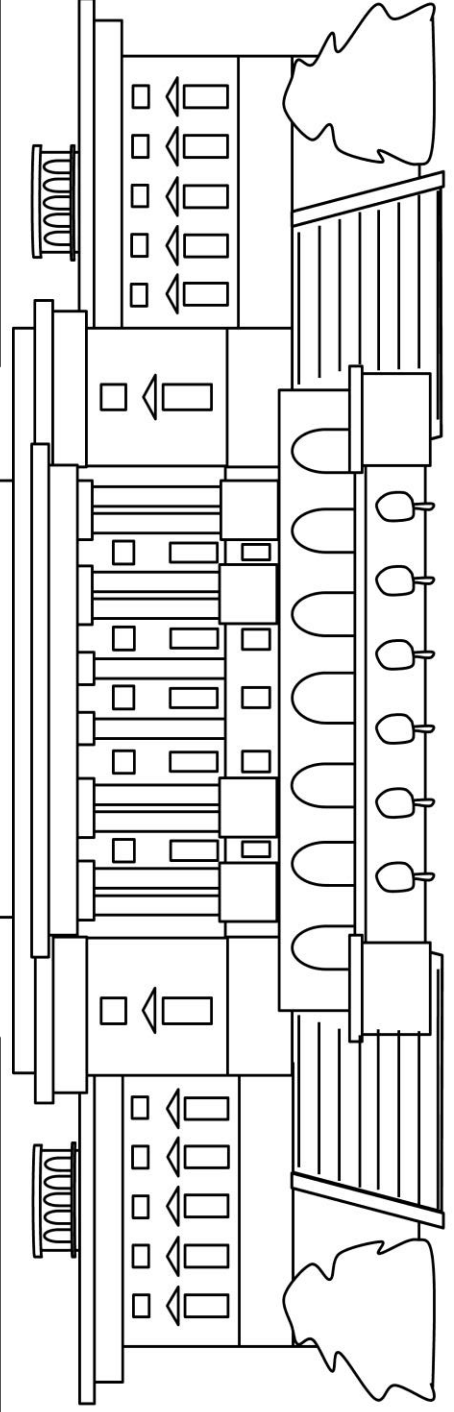

Members

Requirements

Responsibilities

Senate

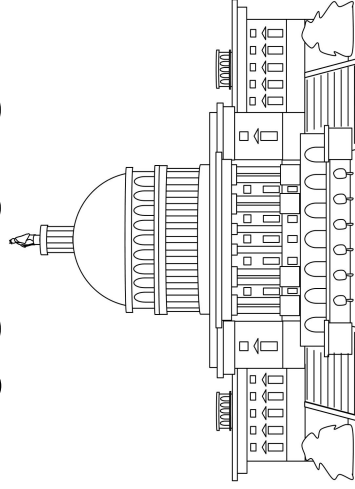

Directions: First use the whole page to fill in the different information required for the Senate part of Congress. Next, cut out each rectangle exactly outside the black line. Then you will stack them on top of each other with the largest rectangle on the bottom so that each title shows and you can staple the four slips of paper together. Then glue the back of the bottom rectangle to the project you are working on or your interactive notebook.

Members

Requirements

House of Representatives

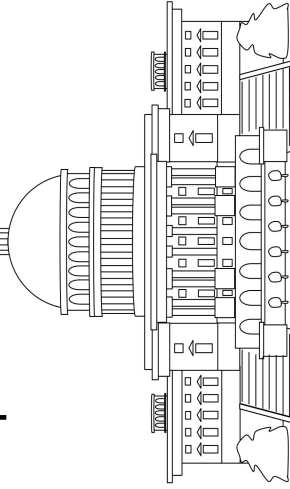

Responsibilities

Directions: First use the whole page to fill in the different information required for the House part of Congress. Next, cut out each rectangle exactly outside the black line. Then you will stack them on top of each other with the largest rectangle on the bottom so that each title shows and you can staple the four slips of paper together. Then glue the back of the bottom rectangle to the project you are working on or your interactive notebook.

2 Senators from
each state X 50
states =

100 Total Members

Members

Must be 30 years
old.

Citizen for 9 years

Live in state they
represent

Requirements

Serve for 6 year
staggered term.
Vice President is Leader.

Meet in the North Wing of
the Capitol Building in
Washington, DC.

Approve or reject
treaties.

Impeach president

Responsibilities

Senate

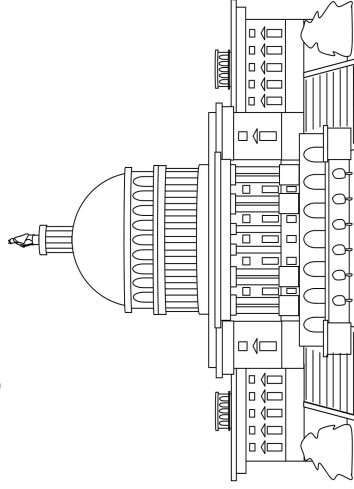

Directions: First use the whole page to fill in the different information required for the Senate part of Congress. Next, cut out each rectangle exactly outside the black line. Then you will stack them on top of each other with the largest rectangle on the bottom so that each title shows and you can staple the four slips of paper together. Then glue the back of the bottom rectangle to the project you are working on or your interactive notebook.

House of Representatives are based on population of state. At least one per state.

Capped at 435 members

Representatives from other parts of the country:

Members

Must be 25 years old.

Citizen for 7 years

Live in district they represent

Requirements

Serve for 2 year staggered term.

Speaker is the leader.

Determines if the president should be impeached
Create Tax Bills
Money

Responsibilities

House of Representatives

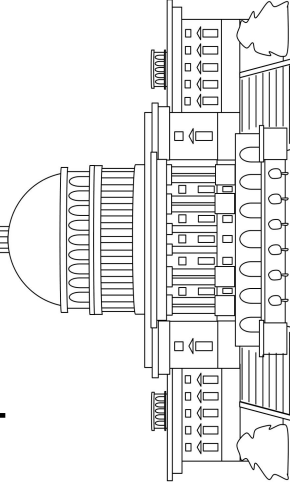

Directions: First use the whole page to fill in the different information required for the House part of Congress. Next, cut out each rectangle exactly outside the black line. Then you will stack them on top of each other with the largest rectangle on the bottom so that each title shows and you can staple the four slips of paper together. Then glue the back of the bottom rectangle to the project you are working on or your interactive notebook.

How a bill



becomes a
law

Students can use this interactive slide-able to review how a bill becomes a law or quiz a friend. To quiz a classmate they simply read each step skipping the words that are underlined. They then check each other if they know the content vocabulary of each step. Have fun learning!

In congress a member
of the House or Senate
1 introduces a bill.

The committees in the
House and Senate
review and approve
2 the bill.

Staple or glue
next step here.

Both the Senate and
the House vote to
3 approve the bill.

The bill then goes to
the President where
he/she can sign the bill
4 or veto (reject) it.

Staple or glue
next step here.

If the President signs
the bill it becomes a
5 law.

If the President vetoes the
bill, it can still become a law
with 2/3 votes from the
6 House and Senate.

Staple or glue
next step here.

Write the titles in bold on the outside of the triangles neatly. Fold the triangle into the middle of the square and glue the back into an interactive notebook, foldable folder or project.

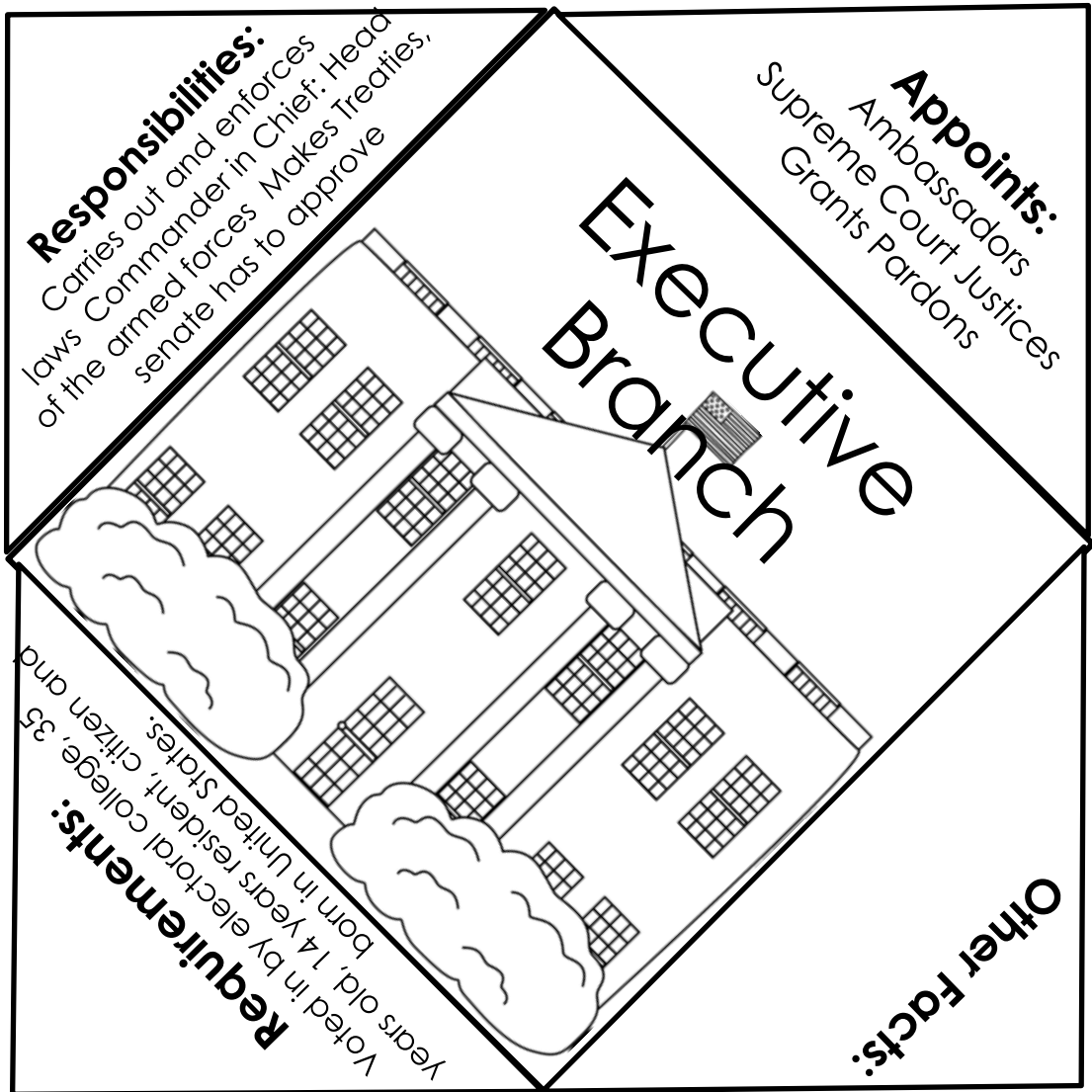

Write the titles in bold on the outside of the triangles neatly. Fold the triangle into the middle of the square and glue the back into an interactive notebook, foldable folder or project.

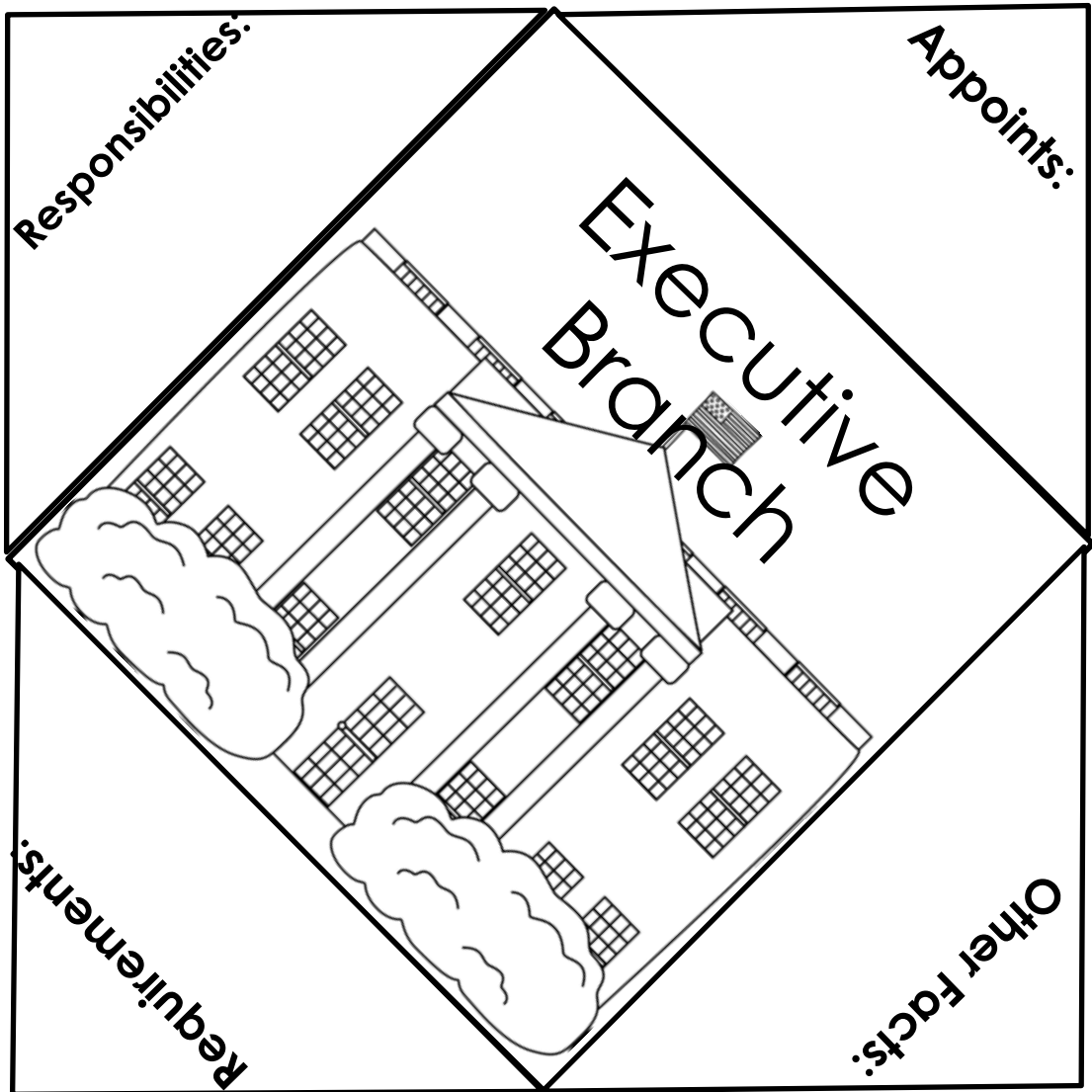

Judicial Branch

The Supreme Court
can turn down laws
passed by

The Judicial Branch
_____ the
laws.

The District Courts
are overseen by

the _____
Court, to make sure
they make fair
decisions.

The president
appoints the

_____ and the _____
has to approve.

This court is the
highest in the
country:

The Supreme Court
is located in _____

Decide if states or
individuals have
followed _____

Three Levels of
Courts:

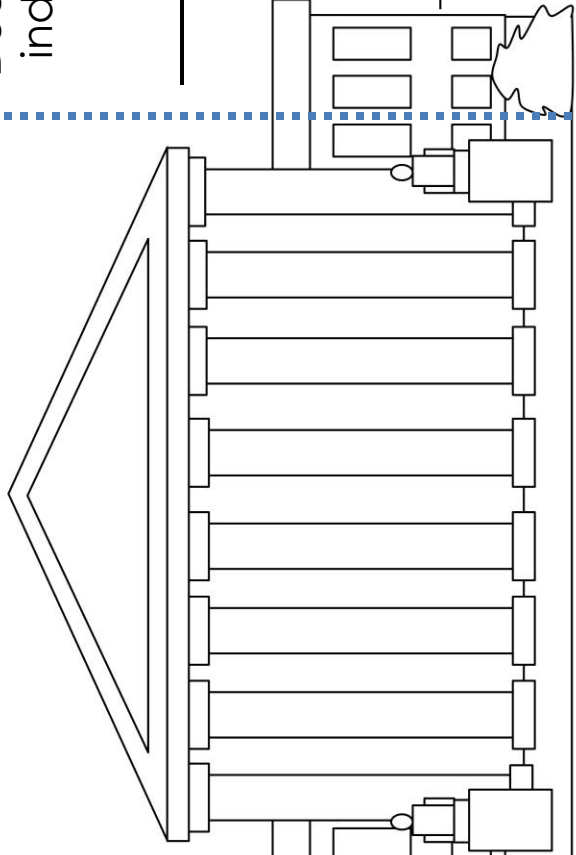

Supreme
Court

Judicial
Branch

down laws passed by _____
 decide if a person is guilty of a _____
 They can also turn _____
 They also _____
 the highest court located in _____
 and supreme. The _____ is _____
 levels include: district, appeals, _____
 The three _____
 hear cases between state _____
 They also _____
 laws follow the _____
 They decide where _____
 and approved by _____
 appointed by the _____
 These men and women are _____
 nine _____
 The judicial branch is led by _____

Judicial Branch

Legislative Branch

The legislative branch is often called _____. It is made up of two groups _____ and House of _____. Both groups can introduce new _____. These bills can become _____. They also have the power to _____ the president and override a _____ with 2/3 votes. They also have the power to declare _____. The Vice President is the leader of the _____ and the _____ is leader of the house.

Executive Branch

Head of Branch: _____

Second in charge: _____

Head of military is called: _____

Has the power to _____ or _____ a bill. Can make _____ or _____ with other countries. If they do wrong, they can be _____. The _____ is a group of people who help the president.

Explain why you think your government should have limited powers that can be checked by other branches of the government?

Name: _____

Understanding Our Government's Checks and Balances

Thank you so much for your purchase! I hope you enjoy using this product with your students. I currently teach fifth grade and will add more activities the next time I teach the unit, so check back the next time you teach the unit and re-download new activities!

As always, if you need something different or need something changed to fit your needs, please email me at sharkbait130@gmail.com before rating my products. I would be happy to add something for you. Please do not leave negative feedback without allowing me to fix the item.

If you liked this unit, you can find more units for upper elementary and middle school in my Teachers pay Teachers store at :

<http://www.teacherspayteachers.com/Store/Tara-Paige>

Thank you again for your purchase and I look forward to hearing how this unit worked for you. You have the most wonderful job in the world and I hope this unit made your life a little easier.

Thanks- Tara Paige



Oceans of Teaching Ideas

